

Typical Conc Pavt, Nonreinf, 7"

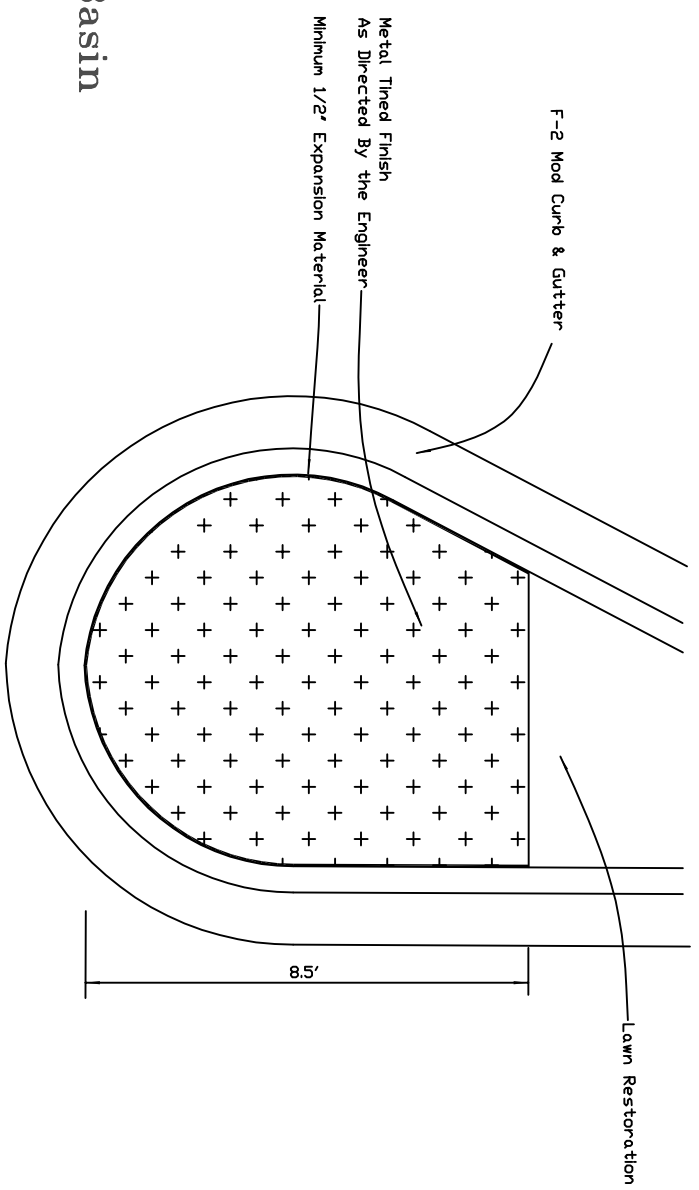

Typical 2' Catch Basin Cross Section

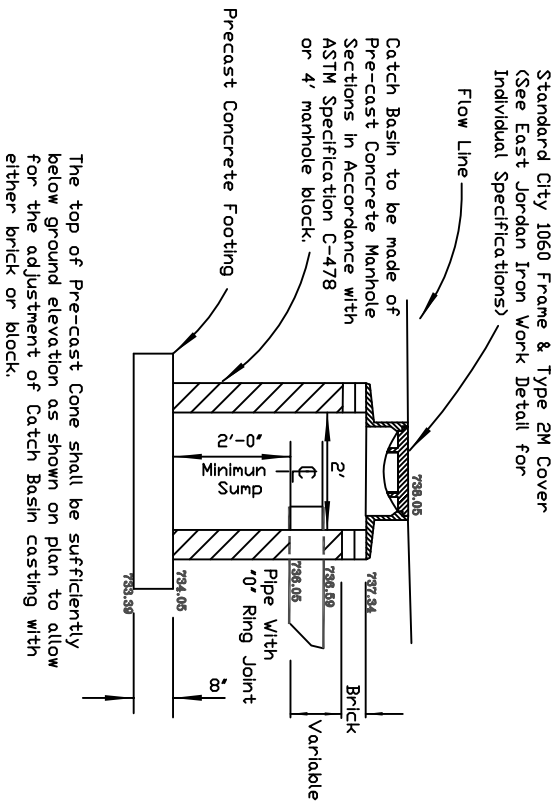

Driveway Detail @ Lansing St.

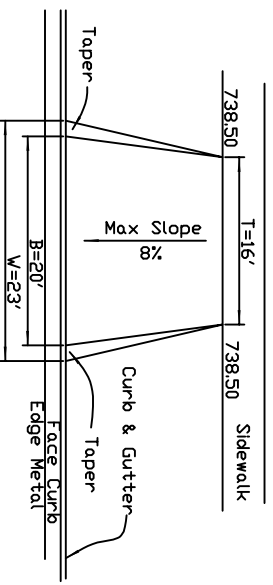

Typical 10" Pavement Cross Section

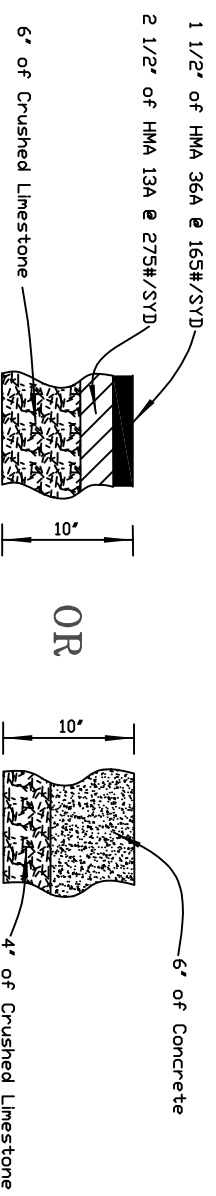

Typical F-2 Modified Curb & Gutter Cross Section

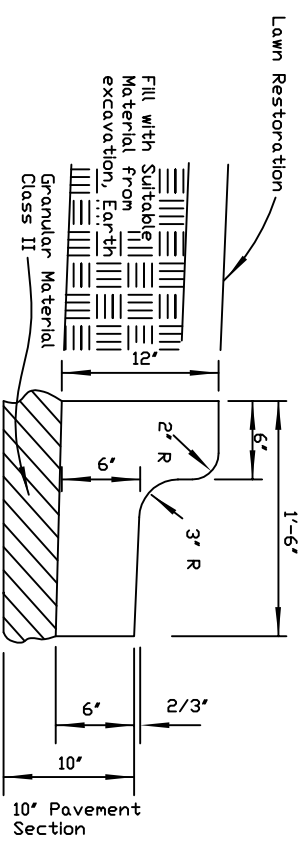

Typical F-2 Modified Ramp Opening Cross Section

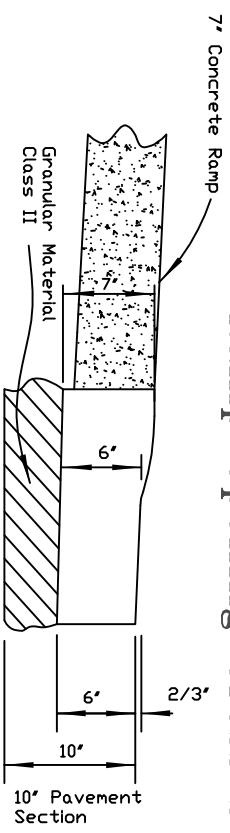

Typical F-4 Modified Curb & Gutter Cross Section

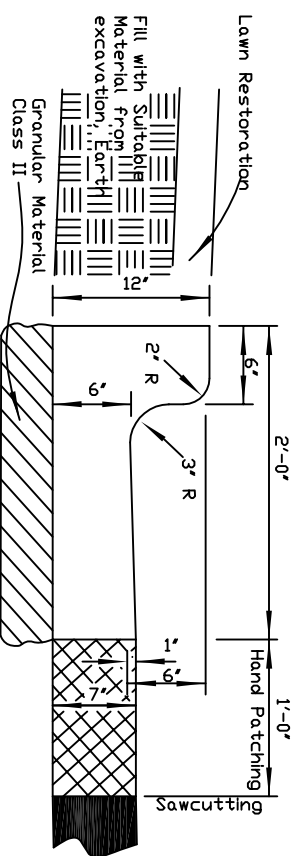

Typical F-2 Modified Drive Opening Cross Section

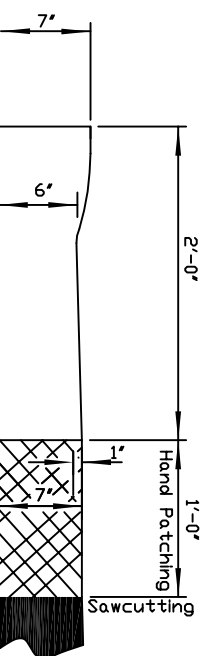

BENCH MARK DATA		NO.	REVISIONS	DATE	BY
ELEV.	DESCRIPTION				